

TYPE 009R



SPECIFICATIONS

Voltage

12V

Capacity

55Ah

CCA (EN)

500CCA (EN)

Pallet Quantity

72

Layout

1

Base Holddown

B1

Terminal

1

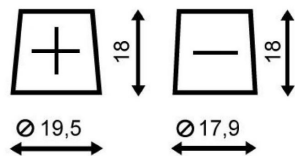

Holddown

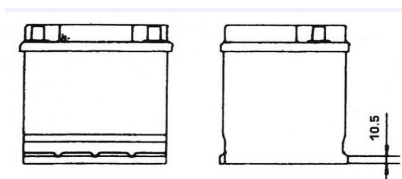

Layout

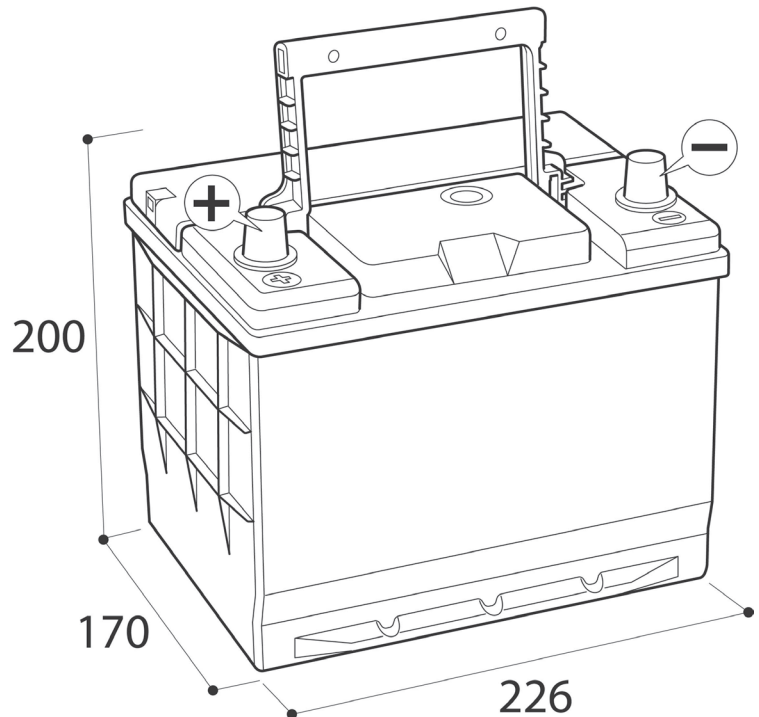
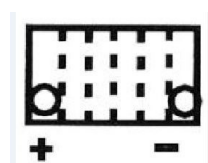

Dimensions

LENGTH	226 mm
WIDTH	170 mm
HEIGHT	200 mm
WEIGHT	13.2 kgs

TRANSPORT INFORMATION

- Classified as "Batteries, Wet, Filled with Sulphuric Acid".
- UN2794
- Class 8
- Packing Group III

