



# RB100-LT

Voltage: 12.8V | Capacity: 100 Ah | Energy: 1280 Wh | Group: 31

LITHIUM IRON PHOSPHATE BATTERY **LiFePO4**

## ELECTRICAL SPECIFICATIONS

Nominal Voltage	12.8 V
Nominal Capacity	100 Ah
Capacity @ 25 A	240 min
Resistance	≤30 mΩ @ 50% SOC
Efficiency	99%
Self Discharge	<3% per Month
Maximum Batteries Connected in Series	1 (Single-Use)

## DISCHARGE SPECIFICATIONS

Maximum Continuous Discharge Current	100 A
Peak Discharge Current	200 A (7.5 s ±2.5 s)
Discharge Over-Current Protection	280 A ±50 A (32 ±10 ms)
Recommended Low Voltage Disconnect	11.0 V
Discharge Under-Voltage Protection	9.2 V (2.3 ±0.08 vpc) (4.7 ±1 s)
Reconnect Voltage	10.0 V (2.5 ±0.1 vpc)
Short Circuit Protection Response Time	200-600 μs

## TEMPERATURE SPECIFICATIONS

Discharge Temperature	-4 to 140 °F (-20 to 60 °C)
Charge Temperature*	-4 to 113 °F (-20 to 45 °C)
Recommended Storage Temperature	23 to 95 °F (-5 to 35 °C)
BMS High Temperature Cut-Off - Discharge	185 °F (85 °C)
BMS High Temperature Cut-Off - Charge	140 °F (60 °C)
Reconnect Temperature	122 °F (50 °C)

\*Refer to charge currents below 32°F (0°C)

## MECHANICAL SPECIFICATIONS

Dimensions (L x W x H)	13 x 6.8 x 8.4" 329 x 172 x 214 mm
Weight	27.9 lbs (12.64 kg)
Terminal Type	M8 x 1.25 x 12mm
Terminal Torque	80 - 100 in-lbs (9 - 11 N-m)
Case Material	ABS & PC blend (UL94-V0 flame rating)
Enclosure Protection	IP67
Cell Type - Chemistry	Cylindrical - LiFePO <sub>4</sub>

## CHARGE SPECIFICATIONS

Recommended Charge Current	5 A - 50 A
Maximum Continuous Charge Current	100 A
Recommended Charge Voltage	14.2 V - 14.6 V
BMS Charge Voltage Cut-Off	15.4 V (3.85 ±0.025 vpc) (1000 ±200 ms)
Reconnect Voltage	14.6 V (3.65 ±0.05 vpc)
Balancing Voltage	14.4 V (3.6 ±0.025 vpc)

## HEATING ELEMENT SPECIFICATIONS

Heating Temperature Range	-4 to 41 °F (-20 to 5 °C)
Heating Time Approximately	1 hour @ 10 A
BMS Heating Element Cut-Off	167°F (75 °C)

## COMPLIANCE SPECIFICATIONS

Certifications	UN 38.3, CE & UKCA (battery) UL1642 (cells) (File# MH64523) IEC62133 (cells)
Shipping Classification	UN 3480, CLASS 9

## DIMENSIONAL SPECIFICATIONS

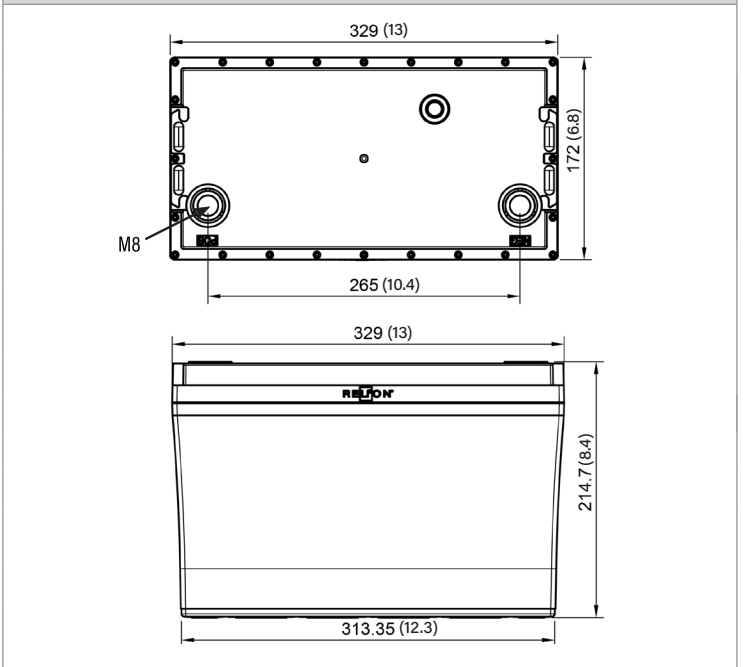



# RB100-LT

Voltage: 12.8V | Capacity: 100 Ah | Energy: 1280 Wh | Group: 31

LITHIUM IRON PHOSPHATE BATTERY **LiFePO4**

## TYPICAL LITHIUM IRON PHOSPHATE CHARACTERISTICS\*

DISCHARGE VOLTAGE CHARACTERISTICS AT VARIOUS RATES  
25°C (77°F)

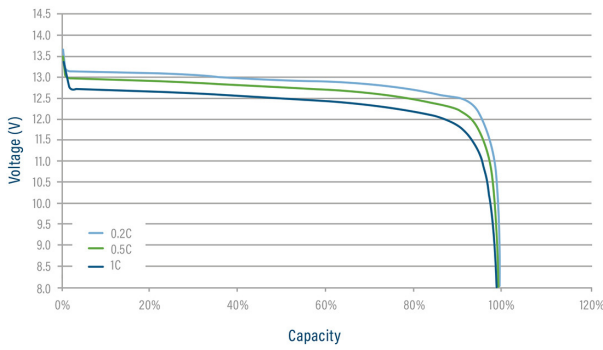

DISCHARGE VOLTAGE CHARACTERISTICS AT VARIOUS TEMPERATURES  
DISCHARGE 1C

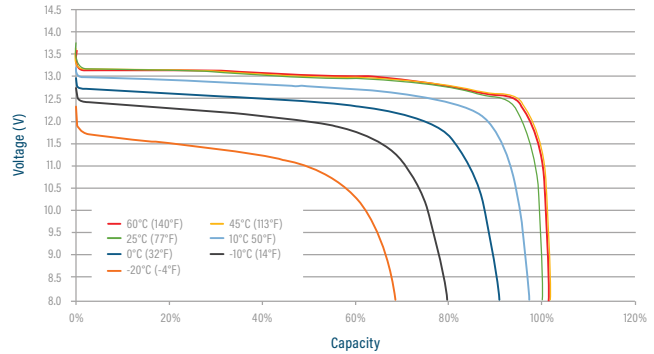

CHARGE VOLTAGE CHARACTERISTICS AT VARIOUS RATES  
CHARGE 0.2C

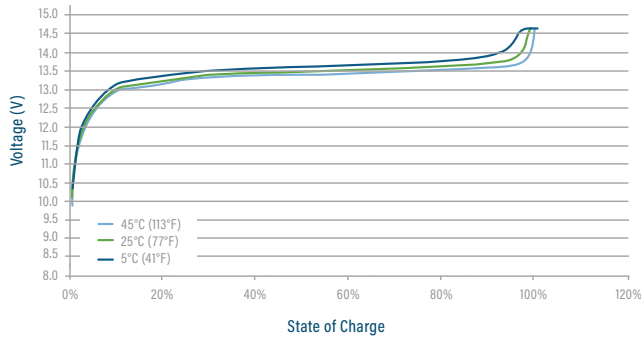

CHARGE VOLTAGE AND STATE OF CHARGE (SOC)  
CHARGE 0.2C @ 25°C (77°F)

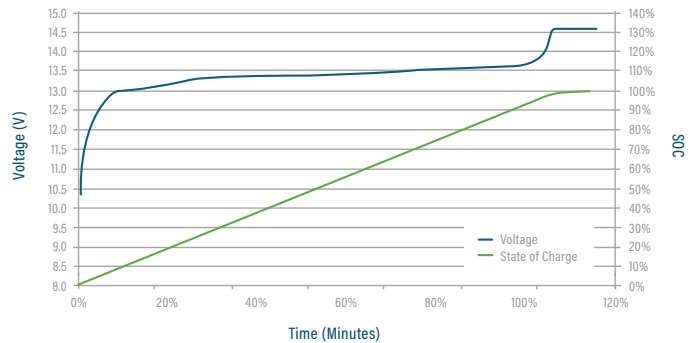

CYCLE LIFE VS. DEPTH OF DISCHARGE (DOD) AT 80%  
DISCHARGE 0.5C/CHARGE 0.5C @ 25°C (77°F)

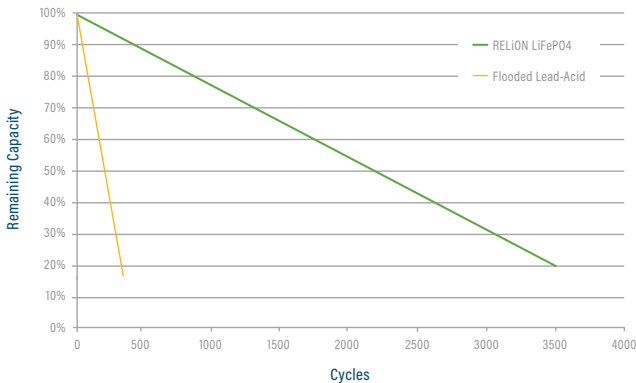

CAPACITY OF RELiON LiFePO4 vs. LEAD ACID  
at VARIOUS RATES OF DISCHARGE

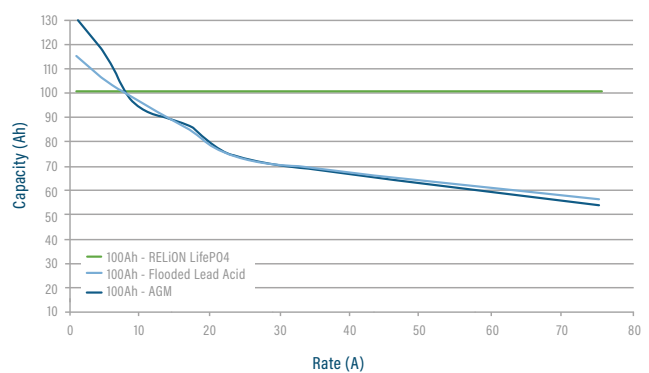

\*Performance between applications and batteries may vary. All results should be independently verified by customer.

